

# Body Composition Analyzer

---

INSTRUCTION MANUAL

---

**SC-240MA**

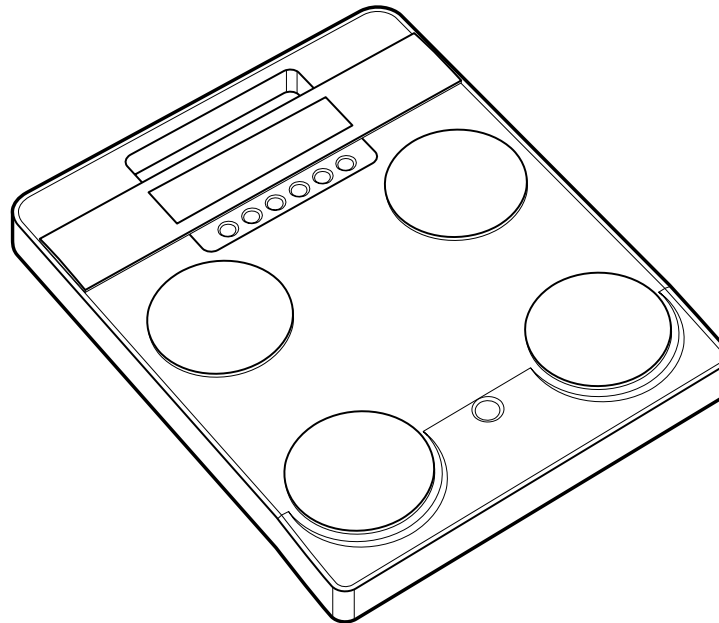

Thank you for purchasing the TANITA Body Composition Analyzer.  
For optimum performance and safety, please read this manual carefully, and  
keep it handy for future reference.

**Safety Notes** ..... 3

**Part Names & Accessories** ..... 6

**Names and Functions of Display Panel & Operation Keys** ..... 7

**Preparation (Power supply)** ..... 8

**Various setting** ..... 9

**How to use (Mode selection)** ..... 10

**How to use (Body composition analyzer)** ..... 11

**How to use (Scale)** ..... 14

**How to use (Scale • Weight Lock Mode)** ..... 15

**How to use (BMI Mode)** ..... 16

**Various criteria** ..... 18

## Disposal



This equipment is electronic device. Please dispose of this equipment appropriately as not the general household waste but electronic equipment. Please follow a regional regulation when you dispose of this.

## Applications

- This equipment can be used in the screening of certain adult diseases and conditions related body weight and composition.
- It can be used in the monitoring and prevention of conditions caused by excessive deposits of fat tissue, such as diabetes, hyperlipidemia, cholelithiasis and fatty liver.
- It can be used in the monitoring of changes in individuals' body composition, related to differences in the ratio of fat tissue to lean.
- It can be used to assess the effectiveness of individuals' nutrition and exercise programmers, both for health and physical fitness.

## Benefits

1. This product is simple to use, and requires no specialized facilities or expertise to take measurements.
2. Measurements can be taken quickly and easily, causing minimal inconvenience to the patient during measurement.

## Caution Symbols

Thank you for purchasing this precision crafted Tanita product. For optimum performance and safety, please familiarize yourself with the **Caution Symbols** below. These symbols are designed to alert the user to potential hazards when using this equipment. Ignoring these **Caution Symbols** may result in serious injury, or damage to the product.

Please be sure to review before proceeding with the INSTRUCTION MANUAL.

- Warning** This symbol indicates the possibility of serious injury if the product is mishandled or instructions are ignored.
- Caution** This symbol indicates the possibility of physical injury or equipment damage if instructions are ignored.
- This symbol indicates general precautions that should be taken when using this product.

### Warning

- **Individuals with a Pacemaker or Other Internal Medical Devices**  
This equipment sends a weak electrical current through the body during measurement. Individuals who have internally implanted medical devices, such as Pacemakers, should not use this equipment due to the risk of malfunction to the device that may be caused by the weak electrical current.
- **Inserting and Removing the Power Cord**  
To reduce the risk of electric shock or product damage, never insert or remove the power cord with wet hands.
- **Do not under any circumstances dismantle or alter the device, as this could result in electric shock or injury as well as adversely affect the precision of measurements.**
- **To prevent fire hazard**  
Use only a correctly wired (230VAC) outlet, and do not use a multiple outlet extension cable.
- **Measurements for physically disabled persons**  
Physically disabled persons should not attempt to take measurements alone, but instead should have their caretakers assist them in using the device.

### Caution

- **When connecting the SC-240MA to a computer ensure that the computer conforms to IEC60950.**
- **Cross Contamination**  
The Body Composition Analyzer should be used with bare feet. Please be sure to clean the scale platform with appropriate disinfectant after each use. Never pour any liquid directly on the scale platform, as it may leak and cause internal damage. Use a soft cloth and appropriate ethyl alcohol to wipe off platform. Do not wipe the platform with strong chemicals.
- **Interpretation of Results**  
The data provided by this machine, as well as any supplementary information such as diet or exercise programs based on this data, should be interpreted by a licensed professional.
- **Please make sure you place the Weighing Platform on a level and stable surface. If the equipment is used when the Weighing Platform is unstable because not all feet are on the surface, there may be a risk of stumbling or inaccurate measurement.**  
Never jump on the Weighing Platform, there may be a risk of stumbling and malfunction of the equipment.

## Safety Notes (continued)

- For the SC-240MA; Ensure you use the original AC adapter. Using an AC adapter (model A30930G) other than the original one may cause malfunction.  
Do not insert or remove the plug by the cable.

### **⚠ Maintenance**

Since this equipment is accurately manufactured and adjusted, please observe the following instructions.

- Users must not disassemble or adjust this equipment. This should be done by trained maintenance agents or certification offices designated under the NAWI directive.
- Never disassemble the equipment as this may cause malfunction. Users must not disassemble or adjust this equipment. Please inspect the equipment in accordance with the regulations in your country.
- Unplug the unit from the wall outlet when it will not be in use for long periods of time.
- Keep the electrodes clean by wiping them with disinfectant.
- Do not drop the unit, and avoid locations with constant vibration.
- Do not put this equipment in direct sunlight, close to heaters or near direct draughts from air conditioners.
- When transferred to any location where there is a difference of more than 20°C, wait 2 hours before using.
- When disposing of this unit, please do so in accordance with the prevailing regulations in each country.

### **⚠ General Instructions for Accurate Measurement**

This equipment sends out a very weak electric current to measure impedance (electrical resistance) of the body. Therefore, in principle, users need to use this equipment with bare feet. Moreover, since impedance fluctuates in accordance with the distribution of body fluid, please observe the following instructions for accurate measurement.

- To prevent a possible discrepancy in measured values, avoid taking measurements after vigorous exercise until sufficiently rested.
- To prevent inaccurately low body fat percentage measurements and other measurement errors, always hold both arms straight down when taking measurements.
- As changes in body water and body temperature can have a major impact on measurements, measurements should be made every day at the same time under similar conditions (always urinating before taking measurements, etc.) to get a more accurate picture of the measurements over time.
- Also, make sure the soles of feet are free of excess dirt, as this may also act as a barrier to the mild current.
- False results may be reported after excessive food / fluid intake, or after periods of intense exercise.
- This equipment is designed for the majority of the population leading healthy lives with a regular lifestyle. For people suffering from sickness, or whose lifestyle is very different from the norm, it is recommended that the data from this product should not be used as an absolute value, but rather as a reference to observe the rate change.
- If there are calluses on the soles of the feet, or an individual is wearing thin nylons, accurate measurement may still be possible. Place 0.5ml of water in the centre of each electrode. This will act as a conductant, and may allow the current to pass freely through a thin barrier.
- Measurement is sometimes impossible on a surface that is strongly vibrating. In this case, please move the equipment onto a surface with little vibration.

- Do not take measurements while using transmitters, such as mobile phones, which may affect readings.

### **<Usage Conditions>**

Temperature Range for Use	: 5°C - 35°C
Relative Humidity	: 30% - 80% (without condensation)

### **<Storage Conditions>**

Temperature Range of Environment	: -10°C - 50°C
Range of Relative Humidity	: 10% - 90% (without condensation)

To avoid malfunctions, avoid storing the equipment where there is direct sunlight, significant temperature changes, the risk of dampness, a large amount of dust, in the vicinity of fires, or where there is the risk of receiving vibrations or shocks.

### **<Power Source>**

Voltage Range	230VAC
Frequency Range	50Hz
Electric Current Range	65mA

GB

GB

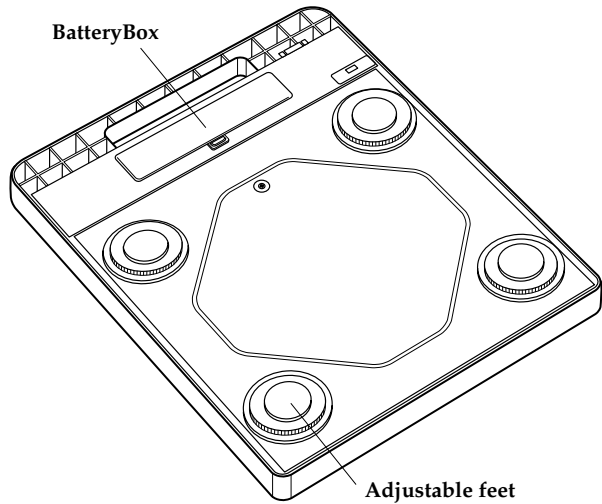
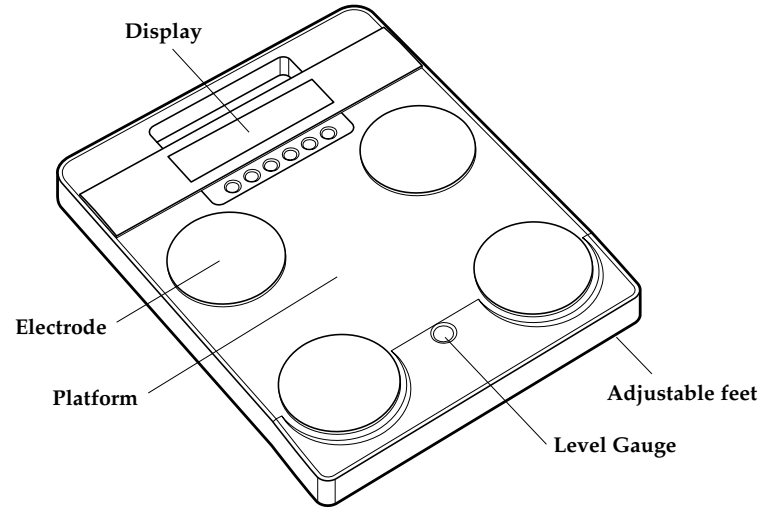

**Accessories**

- Instruction manual (this book)
- AC adapter (Model : A30930G)

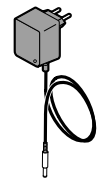

**Level gauge check**



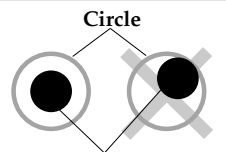

\* For accurate measurement, place the machine as level as possible.  
 \* Rotate the adjustable feet in 4 positions for adjustment so that the bubble of the level gauge reach the centre.



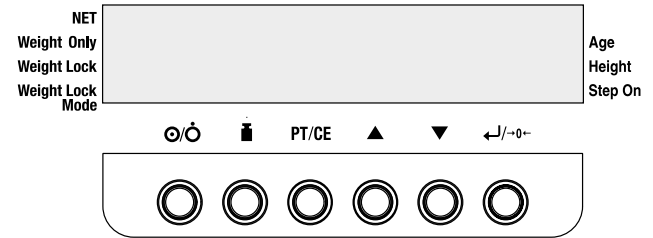















**Air bubble**

In the state that the level gauge is viewed from the top



-  **ON / OFF key** : turn the power ON / OFF
-  **Mode selection key** : Select Body composition analyzer / Weigh scale
- PT/CE** PT / CE : Set preset tare / Clear input values
-  **UP** : Increase numerical values
-  **DOWN** : Decrease numerical values
-  **Enter / Zero reset** : Enter input value / Scale reset to zero / Mode setting
- NET** : Indicates that the clothes weight is input
- Weight Only** : Indicates that the Weight Only (Scale) Mode
- Weight Lock** : Indicates that the Weight is locking
- Weight Lock Mode** : Indicates that the Weight Lock function is activated
- Age** : Indicates that the age is input
- Height** : Indicates that the height is input
- Step On** : Indicates that the measuring start

**<Symbols and their Meanings>**

	Power ON		Power OFF	<b>P T</b>	Preset tare (Clothes weight)
	Male		Female		Athletic mode
	Direct current		Input, Output		Class II Equipment
	Type BF applied part		Caution. Refer to the attached information		Short-circuit-proof safety isolating transformer
	Thermal fuse (115°C)		For indoor use only		WEEE - Waste Electrical and Electronic Equipment Directives
	Alternating current		Negative polarity		⊕ for positive polarity

# Preparation (Power supply)

## <Using batteries>

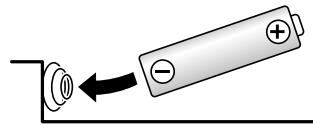
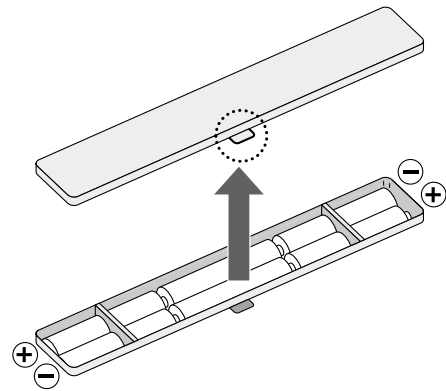

- ⚠ Please change the batteries LR6 (AA) carefully to avoid dropping them on your feet.
- Ensure that the batteries are inserted with the correct polarity ⊕/⊖. If the polarity is incorrect, then the batteries may leak and damage the equipment.
- When not in use for a long time, remove the batteries before storing the equipment.

## <Using the AC adapter>

- (1) Insert the AC adapter jack into the AC adapter inlet on the right side of the main unit.
- (2) Plug the AC adapter into the power outlet.

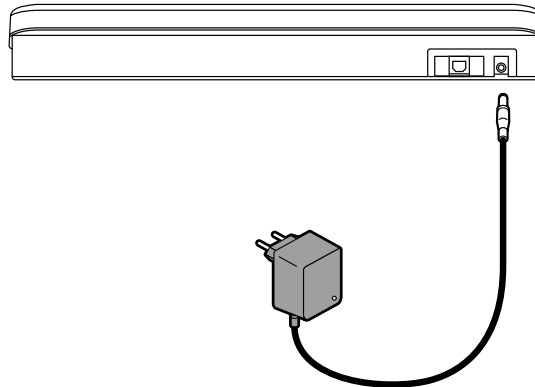

## ⚠ Caution

- This equipment must be used with the included AC adapter (model A30930G).
- Please observe the following instructions for accurate measurement. Measurement may not be possible on the unstable environment. During weight measurement, please don't touch any connecting cable "such as a AC Adapter cable and PC communication cable" to avoid causing unstable scale installation.

# Various setting

## Call up the setting mode.

- 1** Press  $\odot/\odot$  to turn on the power.
- 2** Press  $\leftarrow/0-$  for 1 second.

SET 0 is displayed.

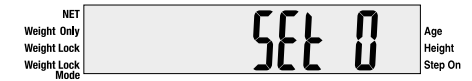
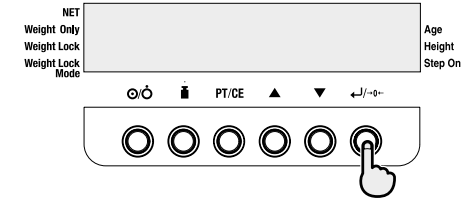

## **3** Select the setting items.

- 1) by  $\blacktriangle$  or  $\blacktriangledown$ ,
- 2) and  $\leftarrow/0-$  key.

- SET1** Set ON / OFF of the beep sound. (0.off or 1.on)
- SET2** Set ON / OFF of the athlete selection. (0.off or 1.on)
- SET3** Set the automatic determination time when inputting. (input range 0-9 seconds)  
\* "0" automatic determination function deactivate.
- SET4** Set the automatic power off time. (0, 5, 10, 30, 60 minutes)  
\* "0" automatic power off function deactivate.

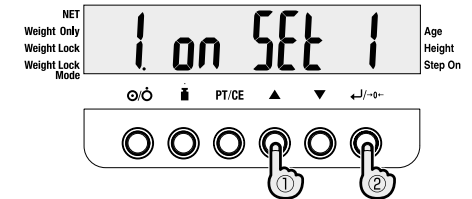

## **4** Input the setting value.

- 1) by  $\blacktriangle$  or  $\blacktriangledown$ ,
- 2) and  $\leftarrow/0-$  key.

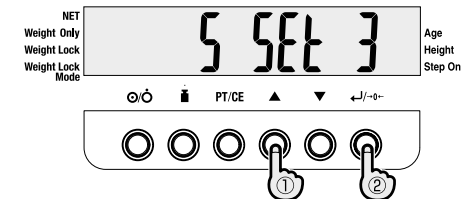

# How to use (Mode selection)

**1** Press  $\odot/\odot$  to turn on the power.

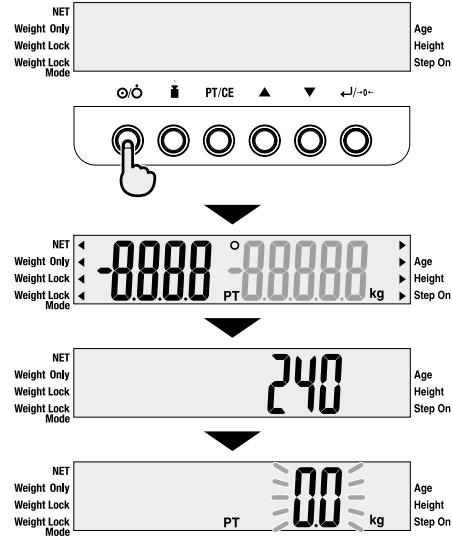

Model name is displayed.

$\odot/\odot$  is displayed (Body composition analyzer).

Mode is selected by  $\blacksquare$  key.

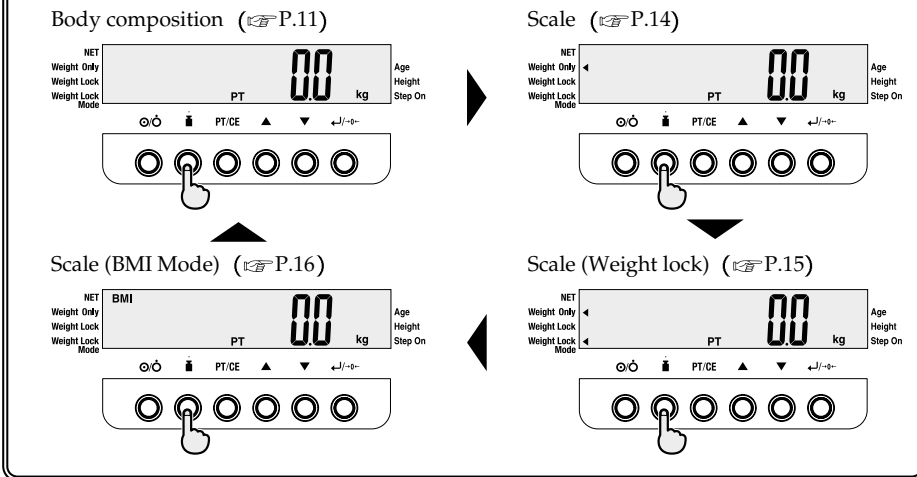

# How to use (Body composition analyzer)

**1** Press  $\odot/\odot$  to turn on the power.

**2** Check that the Body composition analyzer mode is selected (P.10).

**3** Input the clothes weight.  
1) by  $\blacktriangle$  or  $\blacktriangledown$ ,

2) and  $\leftarrow/\rightarrow$  key  
\*  $\text{PT/CE} \rightarrow$  clear the input.

**4** Select the Body type and Gender.  
1) by  $\blacktriangle$  or  $\blacktriangledown$ ,

2) and  $\leftarrow/\rightarrow$  key  
\*  $\text{PT/CE} \rightarrow$  return to previous status.

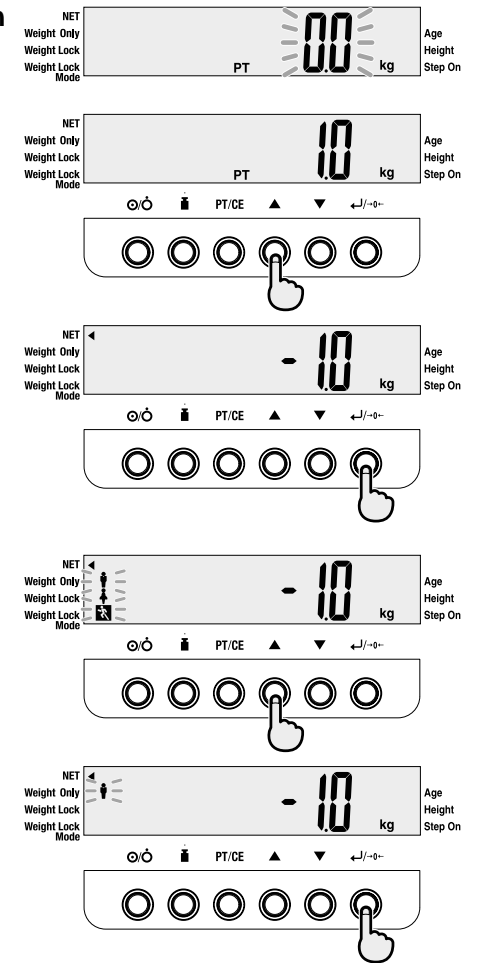

# How to use (Body composition analyzer) (Continue)

## 5 Input the age

1) by ▲ or ▼,

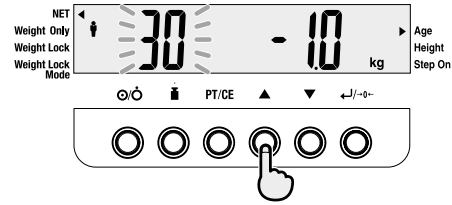

2) and ↵ key

\* PT/CE → return to previous status

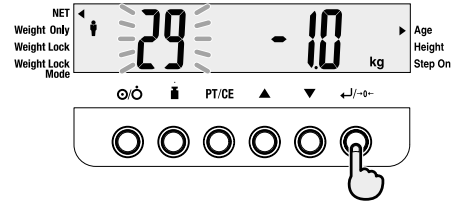

## 6 Input the height

1) by ▲ or ▼,

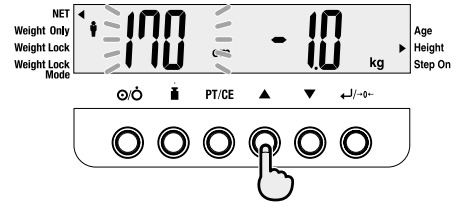

2) and ↵ key

\* PT/CE → return to previous status

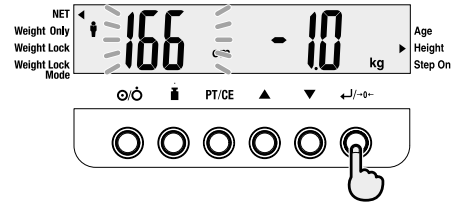

## 7 Step on the platform with bare feet, after "Step on" flashing.

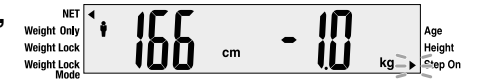

## 8 Measurement completion.

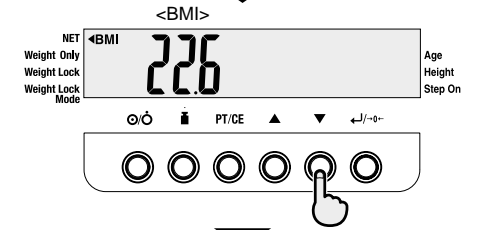

\* PT/CE, ↵ → Clear the displayed result

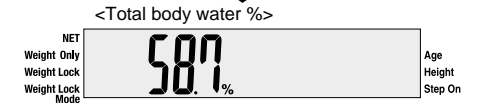

# How to use (Scale)

**1** Press  $\odot/\odot$  to turn on the power.

**2** Check that the Weight only mode is selected (P.10).

**3** Input the clothes weight.  
1) by  $\blacktriangle$  or  $\blacktriangledown$ ,

2) and  $\leftarrow/\rightarrow$  key  
\* PT/CE  $\rightarrow$  clear the input.

**4** Step on the platform, after "Step on" flashing.

**5** Measurement completion.

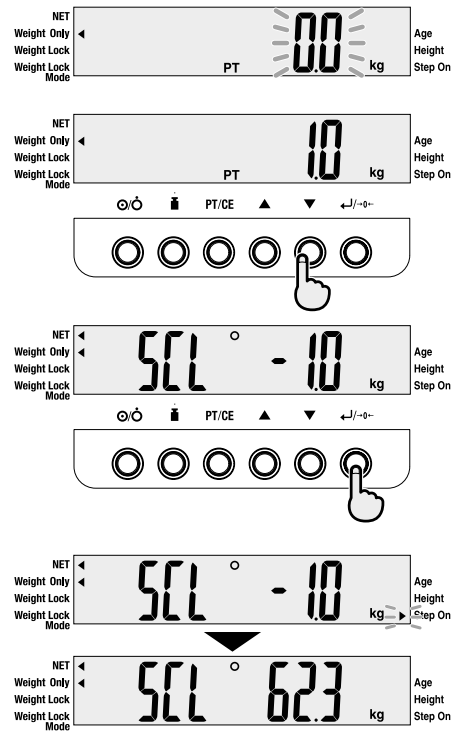

# How to use (Scale • Weight Lock Mode)

Activation of Weight lock function.

**1** Press  $\odot/\odot$  to turn on the power.

**2** Check that the Weight only mode (Weight lock mode) is selected (P.10).

**3** Input the clothes weight.  
1) by  $\blacktriangle$  or  $\blacktriangledown$ ,

2) and  $\leftarrow/\rightarrow$  key  
\* PT/CE  $\rightarrow$  clear the input.

**4** Step on the platform, after "Step on" flashing.

**5** Measurement completion.  
\*  $\leftarrow/\rightarrow$   $\rightarrow$  Clear the displayed result

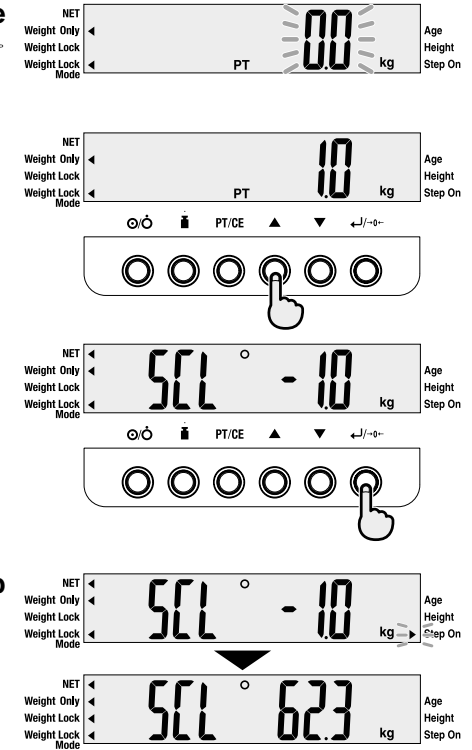



# How to use (BMI Mode)

**1** Press  $\odot/\odot$  to turn on the power.

**2** Check that the BMI mode is selected (P.10).

**3** Input the clothes weight.

1) by  $\blacktriangle$  or  $\blacktriangledown$ ,

2) and  $\leftarrow/0-$  key  
 \* PT/CE  $\rightarrow$  clear the input.

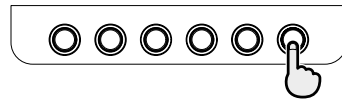
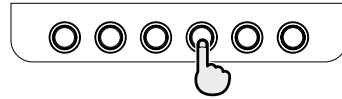
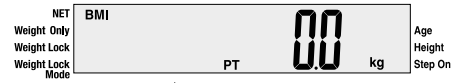
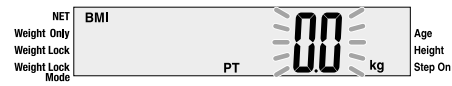

**4** Input the height

1) by  $\blacktriangle$  or  $\blacktriangledown$ ,

2) and  $\leftarrow/0-$  key  
 \* PT/CE  $\rightarrow$  return to previous status

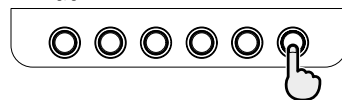
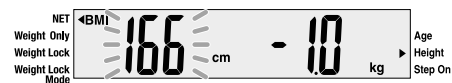
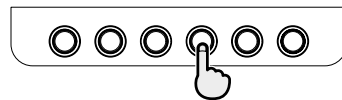
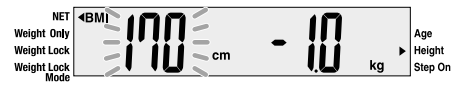

**5** Step on the platform, after "Step on" flashing.

**6** Measurement completion.

\* PT/CE,  $\leftarrow/0-$   $\rightarrow$  Clear the displayed result

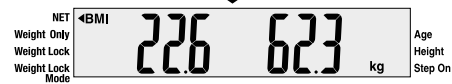
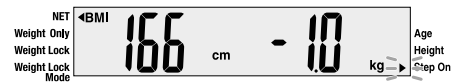

---

---

---

---

---

---

---

---

---

---

---

---

---

---

---

---

---

---

---

---

---

---

---

---

---

---

---

# Various criteria

## Criteria based on body fat percentage

Body fat percentage is the amount of body fat as a proportion of your body weight. Reducing excess levels of body fat has shown to reduce the risk of certain conditions such as high blood pressure, heart disease, diabetes and cancer. The chart below shows the healthy ranges for body fat.

Body Fat Ranges for Standard Children <sup>1</sup>  
 Body Fat Ranges for Standard Adults <sup>2</sup>  
<sup>1</sup> Susan Jebb et al. Obesity Research [a2]. 2004; 12:A156-157  
<sup>2</sup> "New Body Fat Reference Curves for children"  
<sup>3</sup> Gallagher D et al. Am J Clin Nutr 2000; 72:694-701.  
<sup>4</sup> "Healthy percentage body fat ranges: an approach for developing guidelines based on body mass index."

	Underfat	Healthy	Overfat	Obese
5	1 2 3 4 5 6 7 8 9	10 11 12 13 14 15 16 17 18 19	20 21 22 23 24 25 26 27 28 29	30 31 32 33 34 35 36 37 38 39 40 41 42 43 44 45
6	1 2 3 4 5 6 7 8 9	10 11 12 13 14 15 16 17 18 19	20 21 22 23 24 25 26 27 28 29	30 31 32 33 34 35 36 37 38 39 40 41 42 43 44 45
7	1 2 3 4 5 6 7 8 9	10 11 12 13 14 15 16 17 18 19	20 21 22 23 24 25 26 27 28 29	30 31 32 33 34 35 36 37 38 39 40 41 42 43 44 45
8	1 2 3 4 5 6 7 8 9	10 11 12 13 14 15 16 17 18 19	20 21 22 23 24 25 26 27 28 29	30 31 32 33 34 35 36 37 38 39 40 41 42 43 44 45
9	1 2 3 4 5 6 7 8 9	10 11 12 13 14 15 16 17 18 19	20 21 22 23 24 25 26 27 28 29	30 31 32 33 34 35 36 37 38 39 40 41 42 43 44 45
10	1 2 3 4 5 6 7 8 9	10 11 12 13 14 15 16 17 18 19	20 21 22 23 24 25 26 27 28 29	30 31 32 33 34 35 36 37 38 39 40 41 42 43 44 45
11	1 2 3 4 5 6 7 8 9	10 11 12 13 14 15 16 17 18 19	20 21 22 23 24 25 26 27 28 29	30 31 32 33 34 35 36 37 38 39 40 41 42 43 44 45
12	1 2 3 4 5 6 7 8 9	10 11 12 13 14 15 16 17 18 19	20 21 22 23 24 25 26 27 28 29	30 31 32 33 34 35 36 37 38 39 40 41 42 43 44 45
13	1 2 3 4 5 6 7 8 9	10 11 12 13 14 15 16 17 18 19	20 21 22 23 24 25 26 27 28 29	30 31 32 33 34 35 36 37 38 39 40 41 42 43 44 45
14	1 2 3 4 5 6 7 8 9	10 11 12 13 14 15 16 17 18 19	20 21 22 23 24 25 26 27 28 29	30 31 32 33 34 35 36 37 38 39 40 41 42 43 44 45
15	1 2 3 4 5 6 7 8 9	10 11 12 13 14 15 16 17 18 19	20 21 22 23 24 25 26 27 28 29	30 31 32 33 34 35 36 37 38 39 40 41 42 43 44 45
16	1 2 3 4 5 6 7 8 9	10 11 12 13 14 15 16 17 18 19	20 21 22 23 24 25 26 27 28 29	30 31 32 33 34 35 36 37 38 39 40 41 42 43 44 45
17	1 2 3 4 5 6 7 8 9	10 11 12 13 14 15 16 17 18 19	20 21 22 23 24 25 26 27 28 29	30 31 32 33 34 35 36 37 38 39 40 41 42 43 44 45
18	1 2 3 4 5 6 7 8 9	10 11 12 13 14 15 16 17 18 19	20 21 22 23 24 25 26 27 28 29	30 31 32 33 34 35 36 37 38 39 40 41 42 43 44 45
19	1 2 3 4 5 6 7 8 9	10 11 12 13 14 15 16 17 18 19	20 21 22 23 24 25 26 27 28 29	30 31 32 33 34 35 36 37 38 39 40 41 42 43 44 45
20-39	1 2 3 4 5 6 7 8 9	10 11 12 13 14 15 16 17 18 19	20 21 22 23 24 25 26 27 28 29	30 31 32 33 34 35 36 37 38 39 40 41 42 43 44 45
40-59	1 2 3 4 5 6 7 8 9	10 11 12 13 14 15 16 17 18 19	20 21 22 23 24 25 26 27 28 29	30 31 32 33 34 35 36 37 38 39 40 41 42 43 44 45
60+	1 2 3 4 5 6 7 8 9	10 11 12 13 14 15 16 17 18 19	20 21 22 23 24 25 26 27 28 29	30 31 32 33 34 35 36 37 38 39 40 41 42 43 44 45

	0%	10%	20%	30%	40%
5	1 2 3 4 5 6 7 8 9	10 11 12 13 14 15 16 17 18 19	20 21 22 23 24 25 26 27 28 29	30 31 32 33 34 35 36 37 38 39	40 41 42 43 44 45
6	1 2 3 4 5 6 7 8 9	10 11 12 13 14 15 16 17 18 19	20 21 22 23 24 25 26 27 28 29	30 31 32 33 34 35 36 37 38 39	40 41 42 43 44 45
7	1 2 3 4 5 6 7 8 9	10 11 12 13 14 15 16 17 18 19	20 21 22 23 24 25 26 27 28 29	30 31 32 33 34 35 36 37 38 39	40 41 42 43 44 45
8	1 2 3 4 5 6 7 8 9	10 11 12 13 14 15 16 17 18 19	20 21 22 23 24 25 26 27 28 29	30 31 32 33 34 35 36 37 38 39	40 41 42 43 44 45
9	1 2 3 4 5 6 7 8 9	10 11 12 13 14 15 16 17 18 19	20 21 22 23 24 25 26 27 28 29	30 31 32 33 34 35 36 37 38 39	40 41 42 43 44 45
10	1 2 3 4 5 6 7 8 9	10 11 12 13 14 15 16 17 18 19	20 21 22 23 24 25 26 27 28 29	30 31 32 33 34 35 36 37 38 39	40 41 42 43 44 45
11	1 2 3 4 5 6 7 8 9	10 11 12 13 14 15 16 17 18 19	20 21 22 23 24 25 26 27 28 29	30 31 32 33 34 35 36 37 38 39	40 41 42 43 44 45
12	1 2 3 4 5 6 7 8 9	10 11 12 13 14 15 16 17 18 19	20 21 22 23 24 25 26 27 28 29	30 31 32 33 34 35 36 37 38 39	40 41 42 43 44 45
13	1 2 3 4 5 6 7 8 9	10 11 12 13 14 15 16 17 18 19	20 21 22 23 24 25 26 27 28 29	30 31 32 33 34 35 36 37 38 39	40 41 42 43 44 45
14	1 2 3 4 5 6 7 8 9	10 11 12 13 14 15 16 17 18 19	20 21 22 23 24 25 26 27 28 29	30 31 32 33 34 35 36 37 38 39	40 41 42 43 44 45
15	1 2 3 4 5 6 7 8 9	10 11 12 13 14 15 16 17 18 19	20 21 22 23 24 25 26 27 28 29	30 31 32 33 34 35 36 37 38 39	40 41 42 43 44 45
16	1 2 3 4 5 6 7 8 9	10 11 12 13 14 15 16 17 18 19	20 21 22 23 24 25 26 27 28 29	30 31 32 33 34 35 36 37 38 39	40 41 42 43 44 45
17	1 2 3 4 5 6 7 8 9	10 11 12 13 14 15 16 17 18 19	20 21 22 23 24 25 26 27 28 29	30 31 32 33 34 35 36 37 38 39	40 41 42 43 44 45
18	1 2 3 4 5 6 7 8 9	10 11 12 13 14 15 16 17 18 19	20 21 22 23 24 25 26 27 28 29	30 31 32 33 34 35 36 37 38 39	40 41 42 43 44 45
19	1 2 3 4 5 6 7 8 9	10 11 12 13 14 15 16 17 18 19	20 21 22 23 24 25 26 27 28 29	30 31 32 33 34 35 36 37 38 39	40 41 42 43 44 45
20-39	1 2 3 4 5 6 7 8 9	10 11 12 13 14 15 16 17 18 19	20 21 22 23 24 25 26 27 28 29	30 31 32 33 34 35 36 37 38 39	40 41 42 43 44 45
40-59	1 2 3 4 5 6 7 8 9	10 11 12 13 14 15 16 17 18 19	20 21 22 23 24 25 26 27 28 29	30 31 32 33 34 35 36 37 38 39	40 41 42 43 44 45
60+	1 2 3 4 5 6 7 8 9	10 11 12 13 14 15 16 17 18 19	20 21 22 23 24 25 26 27 28 29	30 31 32 33 34 35 36 37 38 39	40 41 42 43 44 45

Copyright (C) 2004 TANITA Corporation. All Rights Reserved.

- Underfat : below the healthy body fat range. Increased risk for health problems.
- Healthy : within the healthy body fat percentage range for your age/gender.
- Overfat : above the healthy range. Increased risk for health problems.
- Obese : high above the healthy body fat range.  
Greatly increased risk of obesity-related health problems.

## What is total body water percentage?

Total Body Water Percentage is the total amount of fluid in a person’s body expressed as a percentage of their total weight. Water plays a vital role in many of the body’s processes and is found in every cell, tissue and organ. Maintaining a healthy total body water percentage will ensure the body functions efficiently and will reduce the risk of developing associated health problems.

Your body water levels naturally fluctuate throughout the day and night. Your body tends to be dehydrated after a long night and there are differences in fluid distribution between day and night. Eating large meals, drinking alcohol, menstruation, illness, exercising, and bathing may cause variations in your hydration levels.

Your body water percentage reading should act as a guide and should not be used to specifically determine your absolute recommended total body water percentage. It is important to look for long-term changes in total body water percentage and maintain a consistent, healthy total body water percentage.

Drinking a large quantity of water in one sitting will not instantly change your water level. In fact, it will increase your body fat reading due to the additional weight gain. Please monitor all readings over time to track the relative change.

Every individual varies but as a guide the average total body water percentage ranges for a healthy adult are:

- Female** :45 to 60%
- Male** :50 to 65%
- Source** :Based on Tanita's Internal Research

**Note:** The total body water percentage will tend to decrease as the percentage of body fat increases. A person with a high percentage of body fat may fall below the average body water percentage. As you lose body fat the total body water percentage should gradually move towards the typical range given above.

# Specifications

<b>Model</b>		SC-240MA
<b>Accuracy Grade</b>	<b>MDD</b>	Class IIa
	<b>NAWI</b>	ClassIII
<b>Power source</b>	<b>AC adapter</b>	Centre minus (model A30930G) Class II
	<b>Battery</b>	LR6 (AA) x 6
<b>Power Consumption</b>		0.5W
<b>Impedance Measurement</b>	<b>Measurement System</b>	Tetra polar Bioelectrical Impedance Analysis
	<b>Measurement Frequency</b>	50 kHz
	<b>Measurement Current</b>	90µA
	<b>Measurement Range</b>	150-1200Ω
<b>Weight Measurement</b>	<b>Measurement System</b>	Strain Gauge Load Cell
	<b>Maximum Capacity</b>	200kg
	<b>Minimum Graduation</b>	0.1kg
<b>Input Items</b>	<b>Clothes Weight</b>	0-10kg / 0.1kg increments
	<b>Gender</b>	Female / Male
	<b>Body Type</b>	Standard / Athletic
	<b>Age</b>	5-99 years (Standard) / 18-99 years (Athletic)
	<b>Height</b>	90-249cm / 1cm increments
<b>Output Items</b>	<b>Weight</b>	0-200.0kg / 0.1kg increments
	<b>Body Fat %</b>	3-75% / 0.1% increments
	<b>BMI</b>	0.1 increments
	<b>Total body water %</b>	15 - 85% / 0.1% increments
<b>Interface Connections</b>		USB
<b>Weight of Equipment</b>		4.7kg
<b>Size</b>		341x437x54mm



0122 This product meets the following requirements ;

- 0123
1. Medical Device Directive (93/42/EEC)  
Safety Standard : EN60601-1:1990, AM No.1:1993, AM No.2:1995  
IEC60601-1:1988, AM No.1:1991, AM No.2:1995  
EMC Standard : EN60601-1-2:2001  
IEC60601-1-2:2001

2. Non-Automatic Weighing Instruments (2009/23/EC)

<EU representative>

**TANITA® Europe B.V.**

Holland Office Centre, Kruisweg 813-A, 2132NG Hoofddorp, the Netherlands Tel: +31 (0) 23-5540188 FAX: +31 (0) 23-5579065 <http://www.tanita.eu>

**Business Location in UK**

The Barn, Philpots Close, Yiewsley, Middlesex, UB7 7RY, United Kingdom Tel: +44 (0) 1895-438577 FAX: +44 (0) 1895-438511

<Manufacturer>

**TANITA® Corporation**

1-14-2, Maeno-cho, Itabashi-ku, Tokyo, Japan Tel: +81 (0) 3-3968-2123 / +81 (0) 3-3968-7048 FAX: +81 (0) 3-3967-3766 <http://www.tanita.co.jp>

**TANITA Corporation of America, Inc.**

2625 South Clearbrook Drive  
Arlington Heights, Illinois 60005, USA  
Tel: +1 847-640-9241 FAX: +1 847-640-9261  
<http://www.tanita.com>

**TANITA Health Equipment H.K.LTD.**

Unit 301-303, 3/F Wing On Plaza, 62 Mody Road,  
Tsimshatsui East, Kowloon, Hong Kong  
Tel: +852 2838-7111 FAX: +852 2838-8667

**TANITA India Private Limited**

Level 9, Platina, C-59, G Block, Bandra Kurla Complex,  
Bandra East, Mumbai 400051, INDIA  
Tel: +91-22-3953-0507 Fax : +91-22-3953-0604